



Specifications

6-bike Capacity: Minimum Footprint with Bikes Inserted: 109" x 72"

Campus Standard 102 Lbs

(allows 12" on each side for handlebars)

Rack with Plaque 120 Lbs

Rack with Plaque Heavy Duty Base 128 Lbs

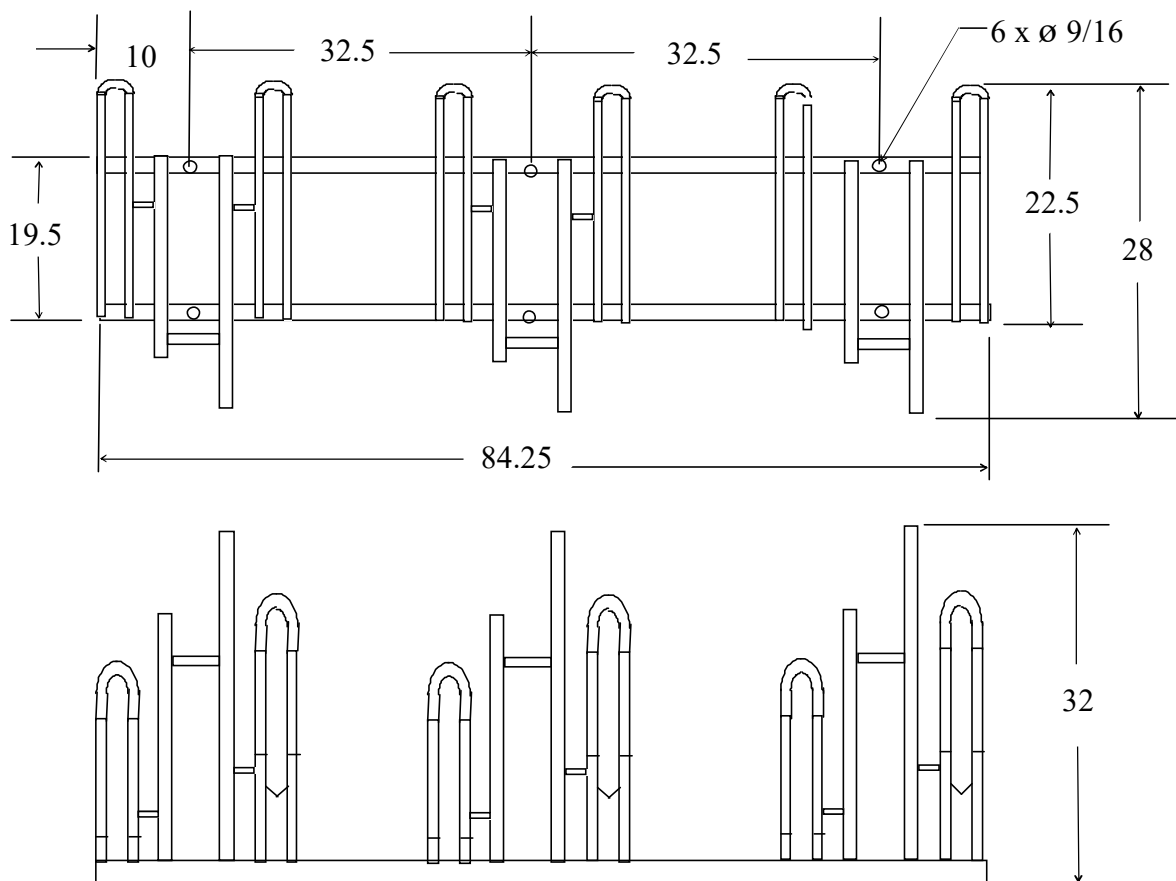

Materials	Finish	Installation
Hot rolled ASTM A36 solid steel bars welded with GMAW (MIG). Standard Base: 1/8" angle Heavy Base: 3/16" angle Wheel Holders: 1/2" diameter Wheel Troughs: 1/8" angle Locking Bars: 5/8" diameter	Standard finish is Hot Dipped Galvanized for superior durability. Optional powder coat is available with sand blasting, primer, color and clear coat (for additional cost).	This rack is free standing and can function without mounting, however, it is recommended that it be secured on concrete with six tamper-resistant stainless steel anchors. (available from Peak Racks)