

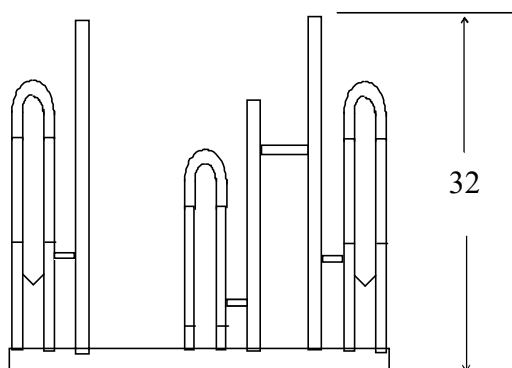

# Specifications

**3-bike Capacity:** Minimum Footprint with Bikes Inserted: 60" x 72"  
 Campus Standard 48 Lbs (allows 12" on each side for handlebars)  
 Rack with Plaque 62 Lbs  
 Rack with Plaque Heavy Duty Base 66 Lbs

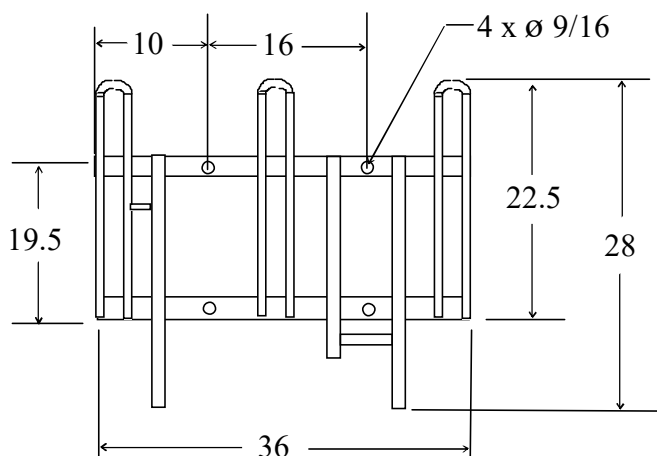

Materials	Finish	Installation
Hot rolled ASTM A36 solid steel bars welded with GMAW (MIG).  Standard Base: 1/8" angle Heavy Base: 3/16" angle Wheel Holders: 1/2" diameter Wheel Troughs: 1/8" angle Locking Bars: 5/8" diameter	Standard finish is Hot Dipped Galvanized for superior durability. Optional powder coat is available with sand blasting, primer, color and clear coat (for additional cost).	This rack is free standing and can function without mounting, however, it is recommended that it be secured on concrete with four tamper-resistant stainless steel anchors. (available from Peak Racks)